

(A) - (G): "Function" Display

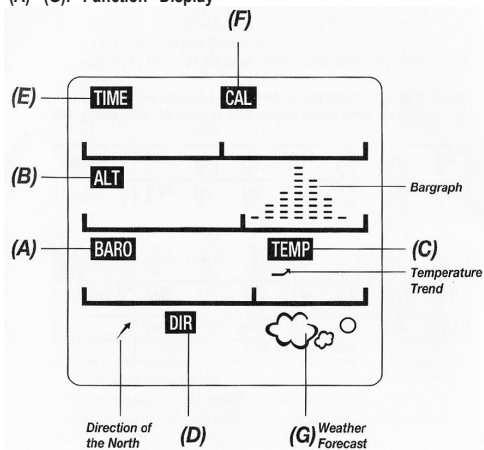

SPECIFICATION

Air Pressure

Pressure Range: 300 to 1100 mb (hPa); 8.85 to 32.45 inHg
Resolution: 1 mb/hPa; 0.01 inHg
Sensing Time: 15 minutes

Altitude

Altitude Range: -700 to 9000 m; -2296 to 29520 ft
Resolution: 0.1 m for -500.0 m to 999.9 m; otherwise 1 m
Sensing time: 2 sec (Sensing time under sleep mode is 15 minutes)

Temperature

Temperature range: -10 to 60°C or 14 to 140°F
Resolution: 0.1°C or 0.1°F
Sensing Time: 1 min

Direction

Range: 0-359°
Resolution: 1°
Sensing time: 1 sec for 1 min
Unit: whole circle bearing, e.g. 255° (or compass bearing e.g. S75°W (=255°))

OPERATION

1. Press **"ON/OFF"** button to switch on. In normal mode, display shows reading of:

- pressure: in unit of mb (mbar) (or inHg).
- height: shows in unit of m (meter) (or ft).
- temperature: shows in unit of °C (or °F).
- direction: shows in whole circle bearing, e.g. 255° (or compass bearing e.g. S75°W (=255°)).
- time: shows and starts time at 12 hour format e.g. 12:00am (or 24 hour format).
- calendar: shows in d/m with day (or m/d).
- bar graph
- weather forecast: show in graphic icon

To operate under scope of above i to viii, press **"mode"** to switch as following:

- "BARO", "ALT", "TEMP", "DIR", "TIME" and "CAL"
- "BARO", "ALT", "TEMP", "TIME" and "CAL"

2. Press and hold **"on/off"** for 3 seconds to switch off.

A. PRESSURE

To look for **BARO** information:

1. Press **"mode"** to pressure mode.

BARO appears, Bar graph for pressure trend of previous 12 hours shows.

Press **"mode"** again to exit and switch to **"ALT"** mode.

2. BARO mode includes following functions:

- Real-time pressure reading in mb (hPa) or inHg.
 - Pressure trend reading (past 12 hours readings)
- To switch between (a) and (b), press "+" and "-" together

3. Air pressure unit switchable

- Go to (2a)
- Press together **"set"** and "+" to switch between mb (hPa) and inHg.

4. Pressure Trend (past 12 hours reading)

- Go to (2b). Display will show one pressure reading for previous past hour with **"- 1 hr"** next to reading.
- Press "+" or "-" to check record of reading in other hours within past 12 hours.

B. ALTITUDE

1. Press **"mode"** to altimeter mode.

ALT appears, Bar graph for altimeter trend of previous 12 hours shows. Press **"mode"** again to exit and switch to **"TEMP"** mode.

2. ALT mode includes functions:

- Real time altimeter reading in meters or feet
 - Max/min altimeter memory recalling
 - Altimeter Trend (past 12 hours reading)
 - High/low altimeter alarm
 - Current ascent/descent rate in ft/hr or m/hr
 - Ascent/descent differential altitude ▲, ▲H; ▼, ▲H
 - Accumulative ascent/descent altitude Σ+, ▲ or Σ+, ▼
- To switch between (a) and (g), press "+" and "-" together

3. Altitude unit switchable

- Go to (2a).
- Press together **"set"** and "+" to switch between m or ft.

4. Setting a reference altitude

Altimeter uses pressure sensor to detect current air pressure, which is then used to estimate current altitude. Unit is pre-programmed with preset values, which are

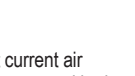
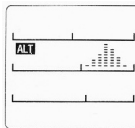
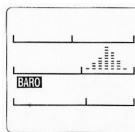
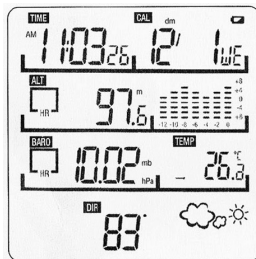

used to convert air pressure reading to altitude values. If a reference altitude is used, unit will calculate relative altitude based on reference altitude (not preset value).

After a reference altitude is set, unit adjusts air-pressure-to-altitude conversion calculation accordingly. Altitude measurements calculated is subjected to error caused by change in air pressure. Therefore, updating reference altitude whenever one is recommended.

- Go to (2a)
- Press and hold **"set"**, **"OFF"** displays, which representing reference altitude is not in use.
- Press "+" or "-" to turn on the reference altitude setting and **"On"** display.
- Press **"set"** to confirm, real time altitude flashing.
- Press "+" once to increase one digit or press and hold "+" for acceleration of increments.
- Press "-" once to decrease one digit or press and hold "-" for acceleration of increments.
- Press **"set"** to confirm and real time altitude change to the preset reference altitude.
- If no reference altitude is set and turn off, the unit uses the preset value for altitude calculation.

5. Switch on/off altitude measurement

User can switch off measurement of altitude.

- Go to (2a), Press **"set"** and "-" to switch off measurement of altitude.
- Display reads "----" It stops measurement of altitude.
- When measurement is stopped, unit keeps updating altitude for every 15 minutes (same as pressure measurement).
- Press **"set"** and "-" together in (2a) to switch on measurement again. Display reads real time reading immediately and update every second immediately.
- Should measurement is switched off, unit will still convert altitude by pressure value in every 15 minutes and bar graph will also be updated accordingly.
- Should measurement be switched off, other value in (2a) to (2g) will keep as last reading.

6. Altitude max/min memory recalling

- Go to (2b), display shows maximum reading.
- Press "+" to show maximum altitude tested. **"MAX"** shows on display.
- To clear memory, in (6ii), press and hold **"set"** reading reset memory to 0 (a beep sound) and start to record maximum reading.
- Press "-" to show minimum altitude tested. **"MIN"** shows on display.
- To clear memory, in (6iv), press and hold **"set"** reading reset memory to 0 (a beep sound) and start to record maximum reading.
- Press "+" and "-" together to (2c).

7. Altitude Trend (past 12 hours reading)

- Go to (2c). Display will show one altimeter reading for previous past hour with **"- 1hr"** next to reading.
- Press "+" or "-" to check record of reading in other hours within past 12 hours.

8. High/low altimeter alarm

- Go to (2d), display shows flashes **"AL"**.
- Press and hold "+" to set and check high alarm, **"AL"**

and, **"HI"** flashes. -700m or previous reading shows on display; or

- Press and hold "-" to set and check low alarm, **"AL"** and, **"LOW"** flashes. -700m or previous reading shows on display.
- To set alarm, Press "+" or "-" to set desired alarm setting. -700m+ 9000m+ -700m, each press 10th, continue press 100th.
- Press and hold **"set"** to confirm and display returns to (2a) real time reading and shows **"HI"** or **"LOW"**
- When reading reaches alarm setting, alarm beep turns on for 15 times. **"HI"** or **"LOW"** flashing.
- Press any key to stop alarm and **"HI"** or **"LOW"** stops flashing; or it stops automatically after 15 times.
- To delete high alarm setting, press **"set"** and "+" in (2d) to delete high alarm set, **"HI"** disappear; or
- To delete low alarm setting, press **"set"** and "-" in (2d) to delete low alarm set, **"LOW"** disappear.
- Press "+" and "-" to exit and switch to (2e).

9. Current ascent/descent rate

- Go to (2e), display shows current ascent rate. **"▲"** shows on display.
- Press "-" to show current descent rate. **"▼"** shows on display.
- Press "+" and "-" together to return to (21).

10. Ascent/descent differential altitude

- Go to (21), display shows ascent differential altitude reading. **"▲ H"** and **"▲"** shows on display.
- Press "+" to show ascent differential altitude reading. **"▲ H"** and **"▲"** shows on display.
- To clear memory, in (10ii), press and hold **"set"**, reading reset to 0 and start to record ascent differential altitude reading.
- Press "-" to show descent differential altitude reading. **"▲ H"** and **"▼"** shows on the display.
- To clear memory, in (10iv), press and hold **"set"** the reading reset to 0 and start to record the descent differential altitude reading.
- Press "+" and "-" together to switch (2g).

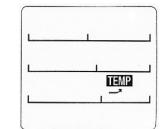
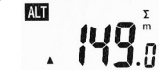

11. Accumulative ascent/descent altitude

- Go to (2g), display shows the accumulative ascent altitude reading. **"E"** and **"▲"** shows on display.
- Press "+" to show accumulative ascent altitude tested. **"E"** and **"▲"** shows on display.
- To clear memory, in (11ii), press and hold **"set"** reading reset to 0 and start to record accumulative ascent altitude tested.
- Press "-" to show accumulative descent altitude tested. **"E"** and **"▲"** shows on display.
- To Clear memory, in (11iv), press and hold **"set"** reading reset to 0 and start to record maximum reading.
- Press "+" and "-" together to return to (2a).



C. TEMPERATURE

To look for TEMP information:

- Press "mode" to TEMP mode. **TEMP** appears. Press "mode" again to exit and switch to "DIR" (or "TIME") mode.
- TEMP mode includes following functions:
 - Real-time temperature reading; and
 - Temperature trend; An arrow shows on display representing the temperature is:
 - rising; or 
 - steady; or 
 - down going 
- °C/°F switchable
 - Go to (2a)
 - Press together "set" and "+" to switch between °C and °F.
- Temperature max/min memory recalling
 - Go to (2a)
 - Press "+" to show maximum temperature tested. "MAX" shows on display.
 - Press "-" to show minimum temperature tested. "MIN" shows on display.



D. DIRECTION

To look for Compass Information:

- Press "mode" to DIR mode. **DIR** appears. Press again to exit and switch to "TIME" mode.
- DIR mode includes following functions:
 - Real time direction reading in whole circle bearing or compass bearing
 - Calibration function
- Type of bearing switchable
 - Press "set" and "+" to switch between different types of bearing.
- Calibration
 - In "DIR" mode, Press and hold "set". "CAL" appears.
 - Turn the unit for 360 degree horizontally.
 - Press and hold "set" to confirm and exit to real-time compass.
- Sleep mode
 - When unit is in compass mode, it starts to measure and update direction every second for 1 minute.
 - Afterward the display read "--".
 - In compass mode, press "set" to reactivate unit to measure and update the direction every second for 1 minute; or
 - Press "mode" to exit and re-enter to DIR mode again.



E. TIME

To look for TIME information:

- Press "mode" to TIME mode. **TIME** shows on the display. Press "mode" again to exit and switch to "CAL" mode.
- TIME mode includes following function:
 - Real time clock
 - Alarm time setting (▲ shows on the display)
 - Timer (count up and count down); ⏸ shows on the display

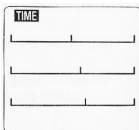

To switch between (a) to (c) one by one, in TIME mode press together "+" and "-" for each switching.

- 12/24 switchable
 - Go to (2a),
 - Press together the "set" and "+" to switch between 12/24 time format.
- Clock Set
 - Go to (2a), press and hold "set". Hour digits flash.
 - Press "+" or "-" to set hour digits. Press "set" to confirm. Minute digits flash.
 - Press "+" or "-" to set minute digits. Press and hold "set" to confirm and go back to real time mode. Second digits return to 00.
- Alarm and Snooze On/Off
 - Go to (2b), press and hold "set" to get into the alarm mode. Hour digits flash.
 - Press "+" or "-" to set hour digits. Press "set" to confirm. Minute digits flash.
 - Press "+" or "-" to set minute digits. Press and hold "set" to confirm.
 - When time is reached, ▲ flashes and beeping sound of alarm will last for 1 minute. Press any key to stop the alarm.
 - To get into the alarm with snooze mode, press "set" again, both ▲ & Z² flashes.
 - When time is reached, ▲ flashed and stop it by pressing any key. While Z² starts flashing. Snooze will sound for every 5 minutes and repeat for 5 times.
 - Press "set" to cancel both function mode ▲ & Z².
 - Press "+" and "-" to return to the real time mode.
- Timer Set (23:5959) Go to (2c), ⏸ flashes. Time digits "0:0000" show on the display.
- Count up
 - Press "mode" to start count up.
 - Press "mode" to pause/stop and re-start.
 - Press together "+" and "-" to go to other time mode during counting while ⏸ flashes during counting.
- Countdown
 - Press and hold "set". Hour digits flash. Press "+" or "-" to set hour digit. Press "set" to confirm.
 - Minute digits flash. Press "+" or "-" to set minute. Press "set" to confirm.
 - Second digits flash. Press "+" or "-" to set second. Press "set" to confirm.
 - When setting is confirmed, all digits stop flashing and all are set well.
 - When all digits are set well. Press "mode" to start count down.
 - Press "mode" to pause and re-start.
 - During counting, may press together "+" and "-" to go to other time function and ⏸ flashes during count down.
 - When time is reached, it sounds for 1 minute and digit remain "0:0000". Or press any key to stop beeping when time is reached.
 - Press "mode", last setting will display. Simply press "mode" again to start count down again.



- Timer clear
 - In timer ⏸ mode, press "mode" to pause counting. Then press "set" to clear. Timer digits return to "0:0000"

F. CALENDAR

To look for CALENDAR information:

- Press "mode" to CAL mode. **CAL** will appear.
- CAL mode includes:
 - date and month showing (dim or mid) with day
 - year showing (2000-2059)

To switch between (a) and (b), press "+" and "-" together.
- Switchable d/m or m/d
 - Go to (2a), press together "set" and "+" to switch between "d/m" or "m/d".
- Language for Day and Calendar set
 - Go to (2a), "d/m" or "m/d" shows.
 - Press and hold "set", display shows "E" representing English for day
 - Press "+" or "-" to select the language. Display show as following:
"E" → "D" → "F" → "I" → "S" → "E"
You can select E for English, D for German, F for French, I for Italian or S for Spanish. They are shown in the language chart below.

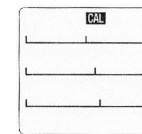

Language	Day-of-the-week							
	Mon	Tues	Wed	Thur	Fri	Sat	Sun	
English	E	Mo	Tu	We	Th	Fr	Sa	Su
German	D	Mo	Di	Mi	Do	Fr	Sa	So
French	F	Lu	Ma	Me	Je	Ve	Sa	Di
Italian	I	Lu	Ma	Me	Gi	Ve	Sa	Do
Spanish	S	Lu	Ma	Mi	Ju	Vi	Sa	Do

- Press "set" to confirm and month digits flash first. Press "+" or "-" to set month. Press "set" to confirm. Then date digits flash.
- Press "+" or "-" to set date. Press and hold "set" to confirm and go back to real time mode.
- Go to (2b). "yr" shows and 4 places digit shows also.
- Press and hold "set", the last 2 digits of year flash (the first 2 digits "20" will not flash). Press "+" or "-" to set year from "00" to "59".
- Press and hold "set" to confirm and go back to real time mode.

G. WEATHER FORECAST

To look for Weather forecast

(It will be shown on the display by all time. Includes icons of the following.)

- sunny ☀
- partly cloudy ☁ ☀
- cloudy ☁
- rainy ☔
- thunder storm ⚡ ☁
- moon and star ★ * ○

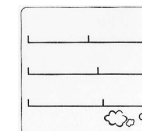

TRACEABLE® HAND HELD DIGITAL BAROMETER INSTRUCTIONS

BACKLIGHT

- Press "B/L" to turn on the back light.
- Press again to switch off. Or it will turn off automatically after 10 seconds.

BATTERY REPLACEMENT

Turn unit over. Use a coin or similar opener to open cover. Insert a new batteries (2 x 3 volts "CR2032" size or equivalent) as the direction indicated. Close the cover.

WARRANTY, SERVICE, OR RECALIBRATION

For warranty, service, or recalibration, contact:

TRACEABLE® PRODUCTS

12554 Old Galveston Rd. Suite B230
Webster, Texas 77598 USA
Ph. 281 482-1714 • Fax 281 482-9448
E-mail support@traceable.com
www.traceable.com

Traceable® Products is ISO 9001:2018 Quality-Certified by DNV and ISO/IEC 17025:2017 accredited as a Calibration Laboratory by A2LA.

Cat. No. 4198

Traceable® is a registered trademark of Cole-Parmer.

©2020 Traceable® Products. 92-4198-00 Rev. 3 050520