

USB Omnidirectional Speakerphone

User Manual

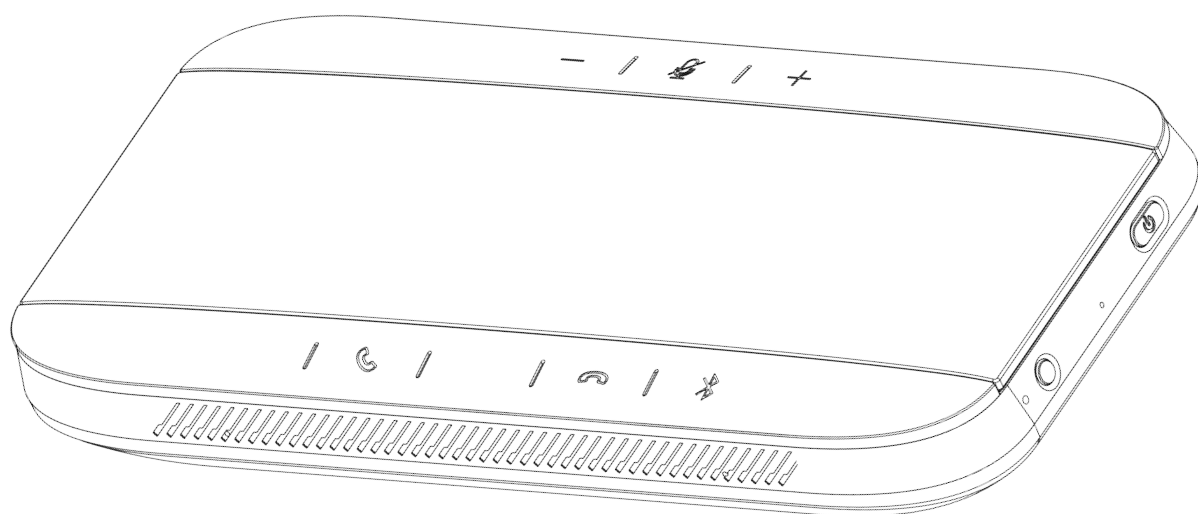

Content

1. Packing Content	1
2. Peripheral Interface	2
3. Operation Instruction	3
4. Product Introduction	4
4.1 USB wired Speakerphone	4
4.2 USB wireless Bluetooth Speakerphone	4
5. Using Instructions	5
5.1 USB wired connection diagram	5
5.2 Bluetooth wireless connection diagram	6
5.3 Key functions and usage	7
6. Reminder Tone	8
7. Product Technical Features	8
8. Function Introduction	9
9. Specification Parameter	10
9.1 Audio parameters	10
9.2 Other Parameters	10
10.Warranty Card	11

1. Packing Content

① M610 Omnidirectional Microphone

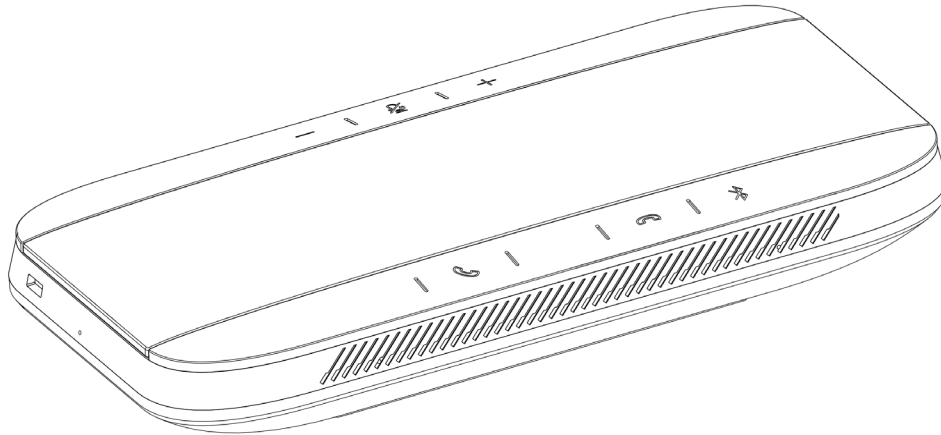

② 1*1.8m Type-C USB cable

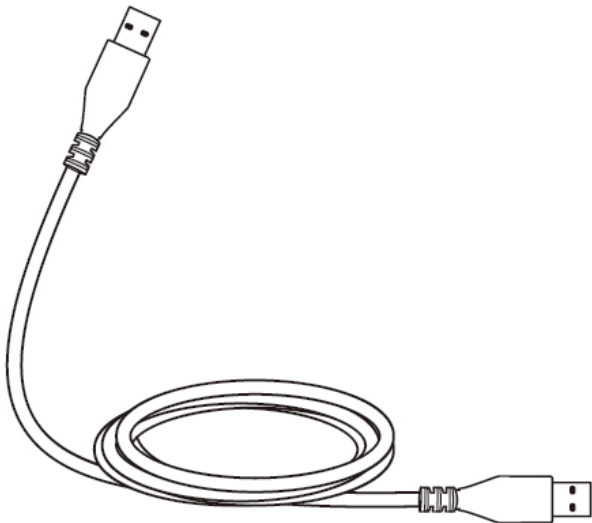

③ 1*Wireless Bluetooth adapter (Only available in M610B)

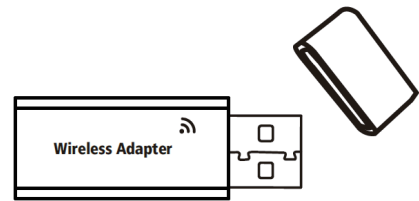

④ User Manual/Warranty Card

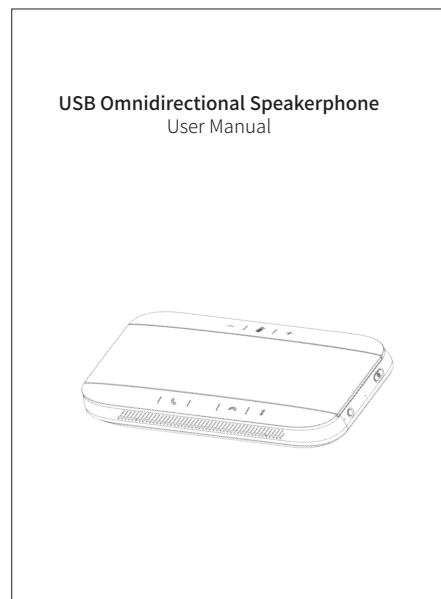

2. Peripheral Interface

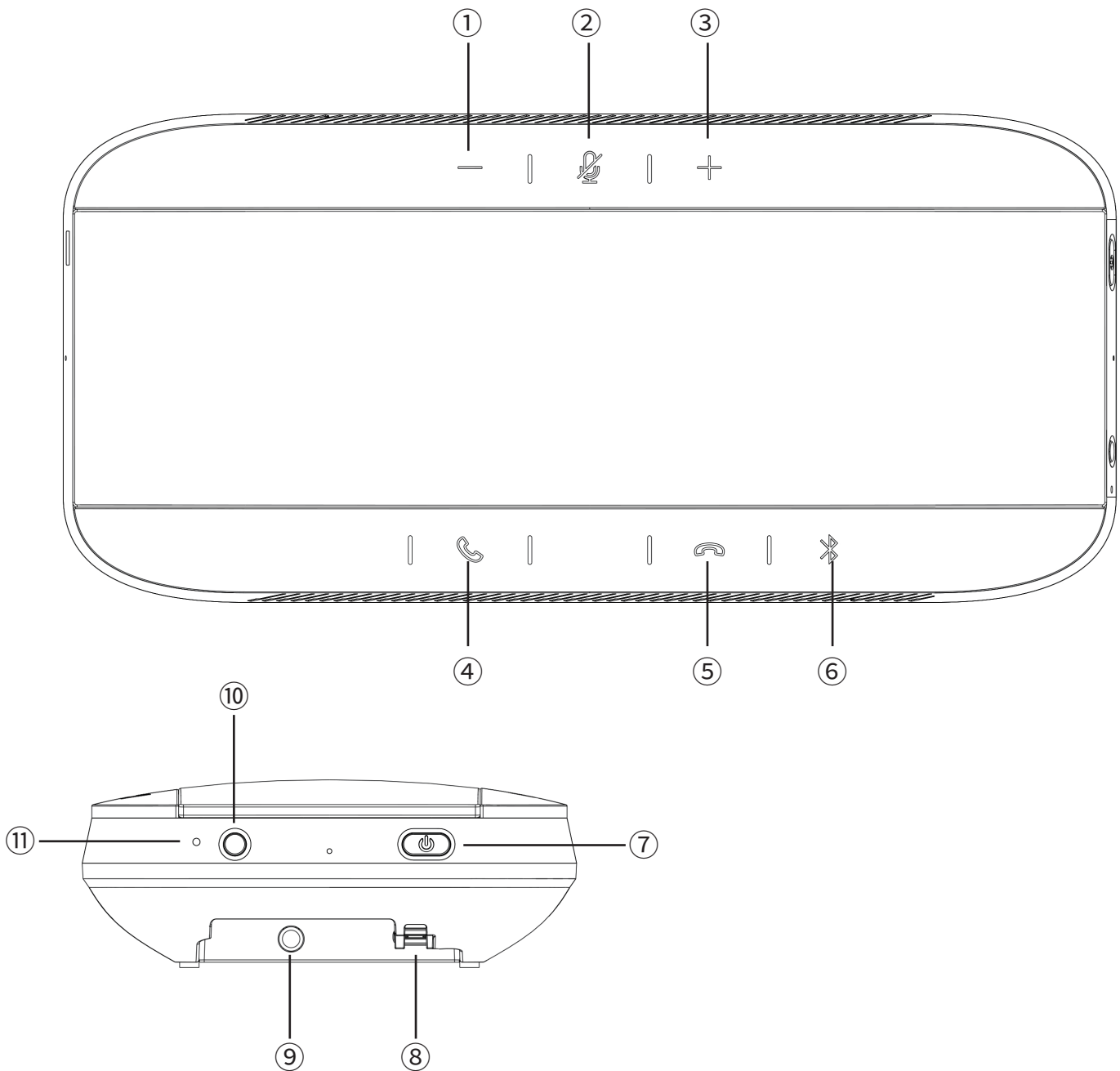

① Volume down

② Mute microphone

③ Volume up

④ Off-hook key

⑤ Hang up key

⑥ Bluetooth mode

⑦ Power on/off

⑧ TYPE-C interface

⑨ 3.5mm audio output

⑩ Expand reserved functions

⑪ Upgrade hole

3. Using Instructions

We solemnly promise that the products you buy are new genuine products, please carefully read the instruction before use.

- After unpacking, please carefully check if the accessories are complete. If there are any missing items, please contact local sales in time.
- During transportation, please use the original packaging to avoid damage caused by pressure, severe vibration, or liquid intrusion , which may affect storage or installation.
- Please pay attention to protecting the microphone during product installation and use to avoid damaging the microphone port or blocking the microphone pickup hole.
- During the use of the product, the microphone should be kept away from strong magnetic sources.
- Do not use any active chemical or corrosive cleaners to clean the surface of the microphone.
- Do not disassemble any components of the microphone. If there is a problem, please contact your local dealer.
- This product enjoys a one-year free warranty service. If there are any quality issues, please contact the manufacturer or authorized dealer for after-sales service.

4. Product introduction

4.1 M610S USB wired Speakerphone

This Speakerphone uses a six-mic ring-shaped controllable array microphone, with 360-degree all-round sound pickup, no howling, no noise, no echo, the human voice is restored to reality, the pickup distance is longer, and maximum pickup radius can reach 6 Meters. At the meanwhile the product adopts full-duplex communication and supports dual-talk mode. It equipped with a USB type-C cable, plug-and-play, driver-free design, supports high-definition audio streaming, and can also support external amplification through the 3.5mm audio output interface.

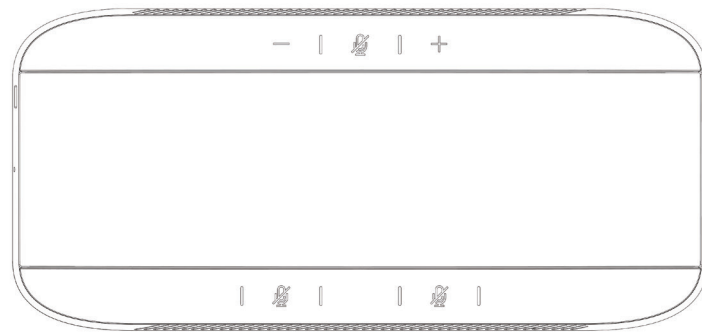

4.2 M610B wireless Bluetooth Speakerphone

This Speakerphone uses six-mic ring-shaped controllable array microphones, with 360-degree all-round sound pickup, no howling, no noise, no echo, the human voice is restored to reality, the pickup distance is longer and maximum pickup radius can reach 6 meters. At the meanwhile the product uses full-duplex communication and supports dual-talk mode. Supports Bluetooth connection to PC, tablet or mobile phone, it effective wireless connection distance can reach up to 30 meters, built-in battery, and has a long standby time of up to 15 hours. It also has a unique built-in low-battery reminder function design.

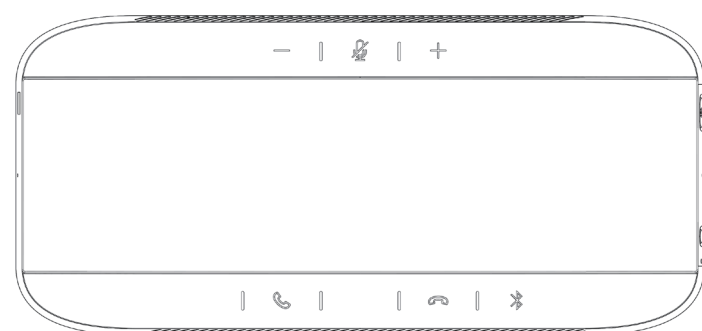

5. Using Instructions

PUS-M610 can be directly connected to system terminal devices such as computers or tablets through the USB-Type C to USB-Type A cable, and is applied in fields such as audio and video conferencing, education, training, and healthcare.

5.1 USB Wired Connection diagram

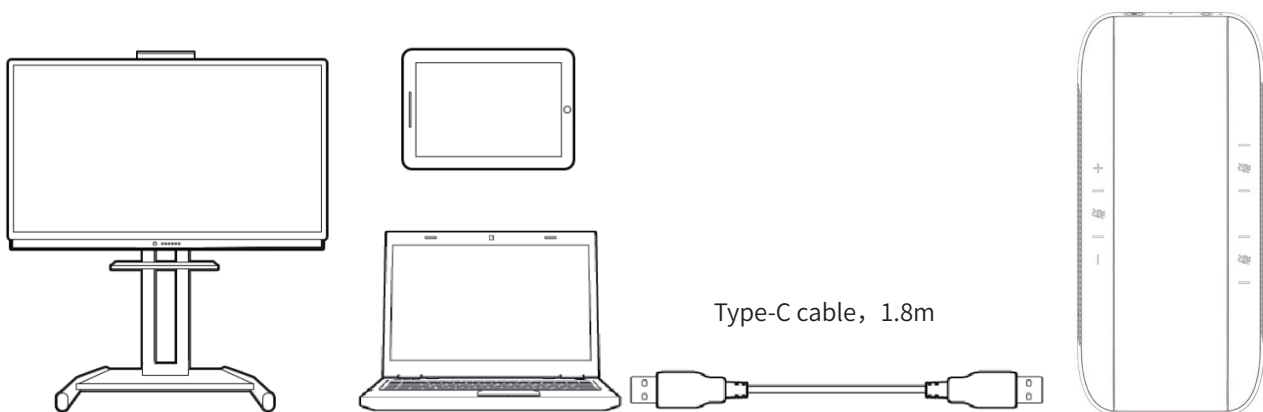

Connect the microphone to conference software or platform applications. Firstly, plug the USB cable of this microphone into your computer or tablet USB interface. At this time, the device will automatically turn on, open and run conference applications or programs on your computer or tablet, such as Skype, Zoom, Microsoft Teams, Cisco WebEx, etc. Then select "M610S" as the microphone and speaker device in your conference software or program to complete.

⚠ Attention

This product adopts ALL-IN-ONE connection design to ensure the normal startup and stability work of M610S , USB only supports USB2.0 and above interfaces to connect to devices such as computers or Laptop and Interactive Display

5.2 Bluetooth wireless connection diagram

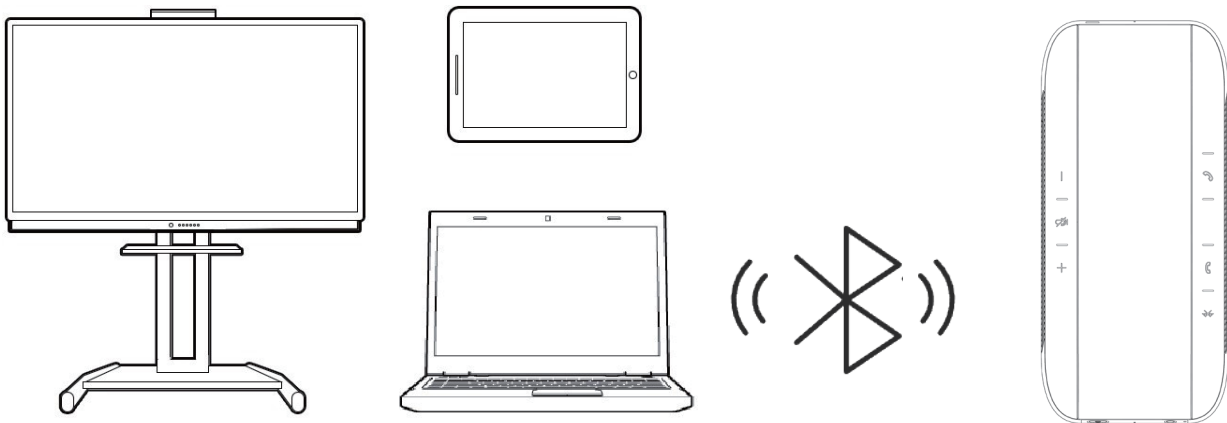

To connect the microphone to conference software or platform applications. Firstly, connect the USB cable/Bluetooth of this microphone to your computer, tablet, or mobile phone. When you are ready to connect the device only through Bluetooth, you need to first press and hold the power button to turn on the device, and then connect with Bluetooth.

If you want to make both USB wired and wireless connections, you only need to make a wired connection first, let the device automatically turn on, and then make a Bluetooth connection.

Start and run meeting software or programs on your computer or tablet, such as Skype, Zoom, Microsoft Teams, Cisco WebEx, etc. Then select "M610B" as the microphone and speaker device in your conference software or program.

⚠ Attention

Bluetooth connection function, only available for M610B USB Wireless Bluetooth omnidirectional microphone.

5.3 Key functions and usage

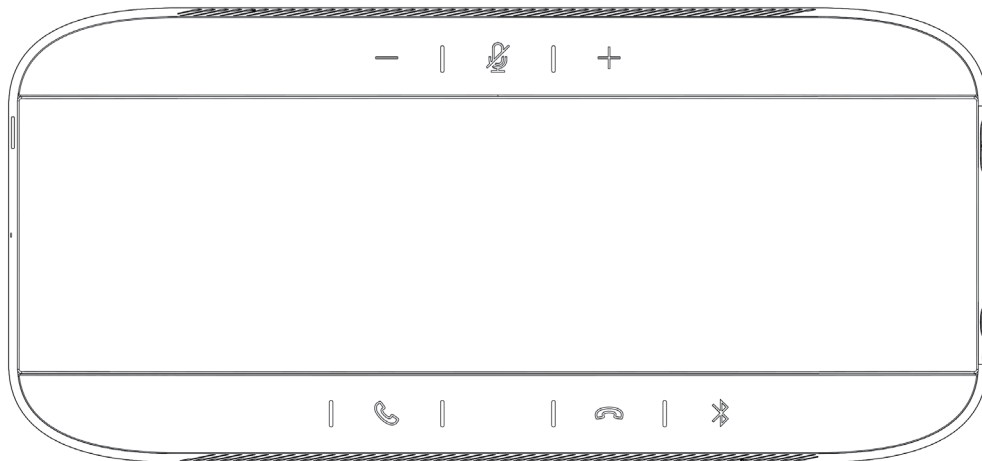

① Volume — :After pressing, the volume gradually decreases, accompanied by a thumping sound.

② Micropone  : Press the button to switch the microphone status. When in the Microphone mute mode, the red light is on.The default indicator is blue.

③ Volume + : After pressing, the volume gradually increases, accompanied by a thumping sound.

④ Off-hook key  : When in Bluetooth connected Phone mode, press to Pick Up Phone.

⑤ Hang Off key  :When in Bluetooth Connected Phone mode, Press to Hang off phone.

⑥ Bluetooth on/off 

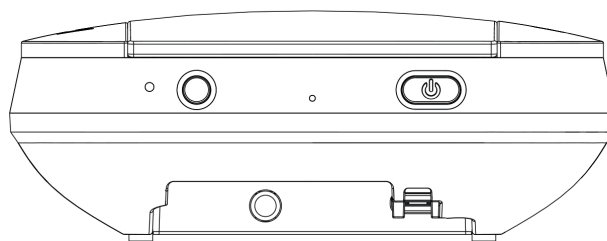

⑦ Power on/off  : Long press to turn on/off.

⑧ TYPE-C interface  : supports power input and audio input.

⑨ 3.5mm audio output hole  : Support 3.5mm audio cable to connect high -power speakers and play sound.

⑩ Expand reserved functions 

6. Reminder Tone

1. Power ON
2. Power OFF
3. Bluetooth Pairing
4. Bluetooth Connected
5. Bluetooth Disconnected
6. Low Power

7. Product Technical Features

1. Deep echo cancellation (AEC): > 65dB, Echo length: < 500ms.
2. Microphone pickup range: 6 meters(Radius).
3. Automatic gain: 1-5m sound without significant attenuation.
4. Dual-talk function: Supports full-duplex dual-talk.
5. Active call noise reduction: eliminate noise unrelated to meetings (such as environmental noise from air conditioning, fans, etc).
6. Howling suppression: To avoid self excitation of the device causing howling when the recording source and sound source are close together.
7. Reverberation suppression: deal with ambient echoes in the meeting room to improve speech tailing.
8. Lossless mixing: Lossless mixing of multiple tracks.

8. Function Introduction

1. USB wired audio connection
2. Wireless Bluetooth audio connection (M610B only)
3. 3.5mm audio output
4. Power on
5. Ultra long endurance, with a continuous endurance of more than 15 hours (M610B only)
6. Automatic shutdown without any operation within 45 minutes (M610B only)
7. Bluetooth Battery display (M610B only)
8. Standalone Bluetooth adapter (M610B only)
9. OTG firmware upgrade

9. Specification Parameters

9.1 Audio parameters

Parameters \ Mode	Microphone	Loudspeakers
Sensitivity (1KHz)	-26dB \pm 2dB SPL/mv	75dB/W
Impedance (1KHz)	/	4 Ω
SN Ratio (SNR)	64dB	95dB
Total harmonic distortion (THD)	0.2%	5%
Frequency Response	100~22KHz	100~20KHz
Input Power	/	5W

9.2 Other Parameters

Input Voltage	5V
Max Consumption	6.2W
Storage temperature and humidity	-10°C ~+60°C /20%~95%
Operating temperature and humidity	-10°C ~+50°C /20%~90%
Operation Environment	Indoor
Accessories	1.8m Type-C cable \times 1, User manual/warranty card \times 1

10. Warranty Cards

With this card for warranty, please keep it for product warranty, cut this page when you need for RMA Service.

Products Warranty Cards

User Information

Date: _Day_ Month _Year

Name		Purchased Date	
Add			
Tel/Fax		Post Code	
Purchased Place			
Model/Specs		S/N	
Malfunction Phenomenon			
Distributor(Chop)		User Signature	

User files are warranty and basic documents, please fill in and keep them carefully & Saved it.